

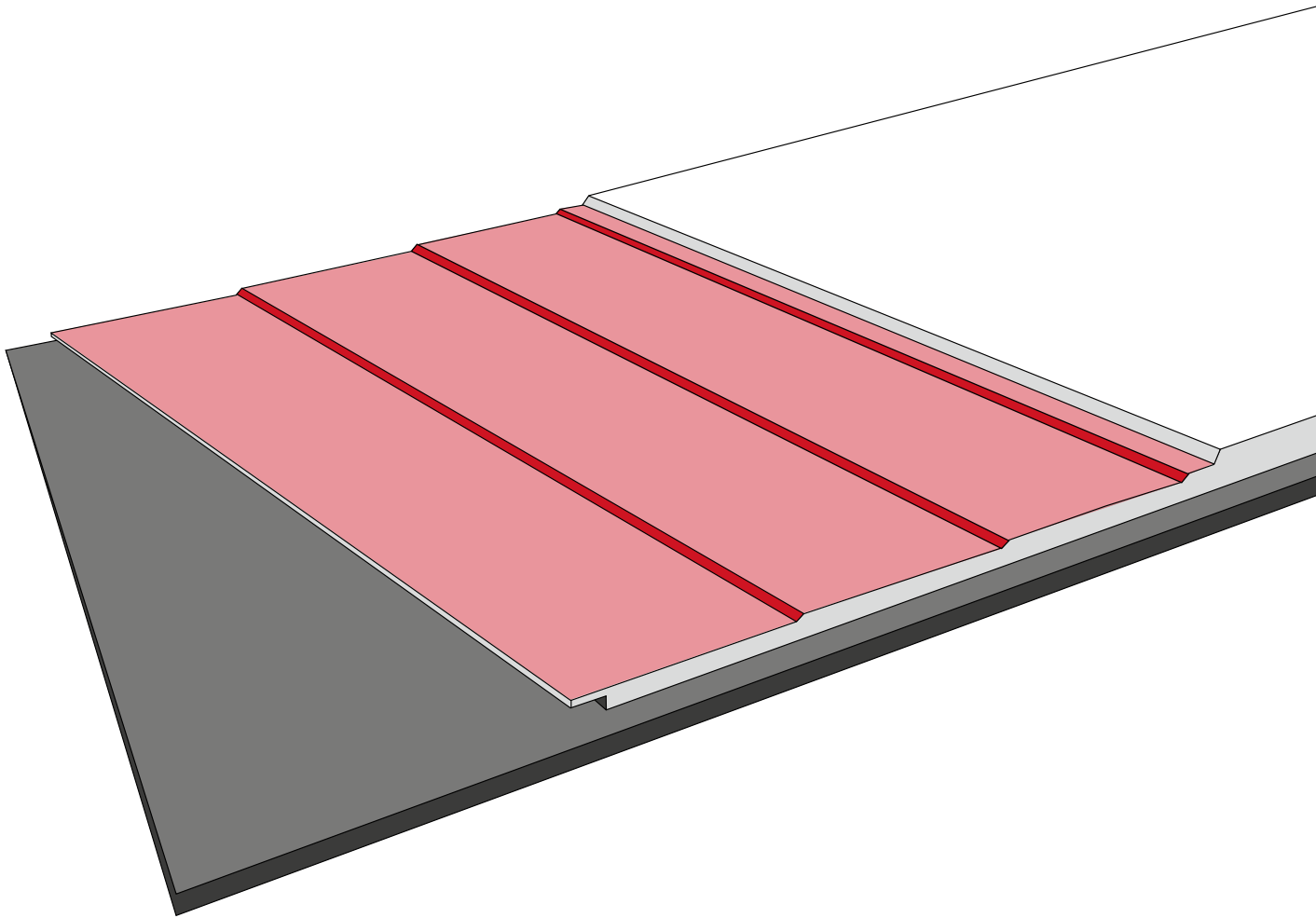

NILOS

Working instructions for splicing fabric belts using a hot process



NILOS GmbH & Co. KG
Reisholzstr. 15
40721 Hilden • Germany
Phone: +49 2103 951 - 0
Fax: +49 2103 951 - 209
info@nilos.de
www.nilos.de









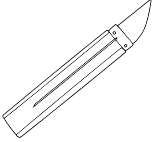
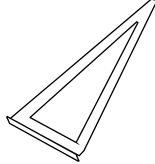
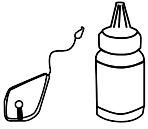
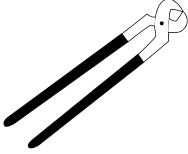

Contents

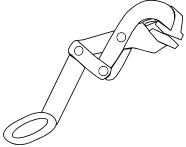
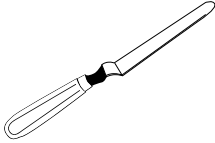
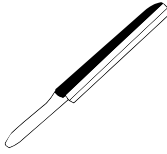
| | |
|---------|---|
| 4 - 5 | Material requirements and legend |
| 6 - 7 | Safety instructions |
| 9 | 1. Preparations |
| 10 | 2. Set-up of the vulcanising press |
| | 3. Preparing the ends of the belt |
| 11 | 3.1 Splicing guidelines |
| 11 | 3.2 Splice lengths in accordance with DIN |
| 11 | 3.3 Belt slice for conveyor belts |
| 11 | 3.4 Running direction |
| 12 | 3.5 Plotting the belt splice |
| 12 | 3.6 Conveyor belts with three plies |
| 12 | 3.7 Activating the adhesive |
| | 4. Processing the ends of the belt |
| 14 - 16 | 4.1 Work steps for producing the splice |
| 17 | 4.2 Cooling down the splices |
| 18 - 19 | 5. Splice report |

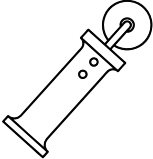
Working instructions for splicing fabric belts - hot process

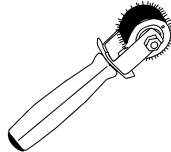
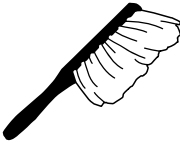
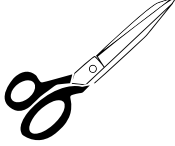
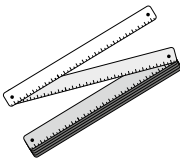
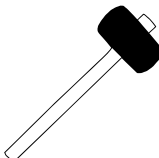

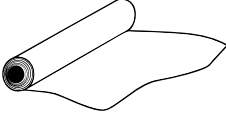

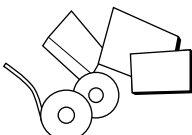

Material requirement

| Material | Item No. | Material | Item No. | Material | Item No. |
|---|--|---|---|---|--|
|  | K 0605 Cobbler's knife |  | K 0623 Pulling hook |  | K 0482 Stop bracket |
|  | K 0661 + K 0661A Chalked string with powder |  | K 0745 Pliers |  | K 0626 Brush, size 12 |
|  | K 0646 Wire grip |  | K 0609 Angled blade |  | K 0634 Whetstone with wooden handle |
|  | K0792-A + K0731 Rotary sander for working rubber |  | (For item No. see page 19 of tool catalogue) Fibre disks |  | K 0747 / 62 / 61 Wheel wire brushes |
|  | H 0612 Knurled roller |  | K 0615 Flat roller |  | K 0613 Piercing roller |
|  | K 0627 Hand brush |  | K 0620 Rubber scissors |  | K 0654 Screw clamp |
|  | K 0624 Folding rule |  | K 0628 Rubber hammer |  | K 0607 Layer-separating knife |
|  | H 0317-C Silicon paper (one-time use) |  | H 0316 Shirting roll (multiple use) |  | H 0318 Printing blanket (multiple use) |
|  | On request Splicing kits (cover plate core plate STG strips) | | | | |

Working instructions for splicing fabric belts - hot process

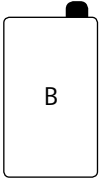

Material requirements and legend

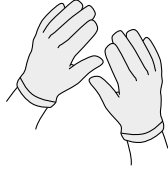
| Material | Item No. | Material | Item No. | Material | Item No. |
|---|---|---|--|---|---|
|  | H 0312 STG-B, 650 g can Vulcanisation solution, benzine-based |  | H 0308 L-1000, 650 g can Vulcanisation solution, benzine-based |  | H 0313 STG-FW, 1000 g can Vulcanisation solution, dichloromethane -based |
|  | H 0315 Type B, 0.5 L Cleaning agent, benzine-based |  | K 0658 Safety goggles |  | K 0662 Protective gloves |

Legend

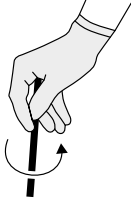
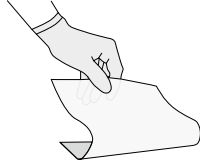
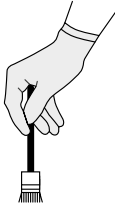
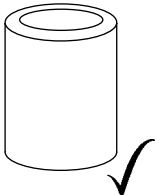
| | | | | | |
|---|------------------------------|---|-------------------------|---|---------------------------|
|  | Processing time |  | Stir |  | Remove protective film |
|  | Coat thinly and evenly |  | Ready for processing | | |

Working instructions for splicing fabric belts - hot process



Emergency information
Phone: +49 173 5306827

Vulcanisation solution STG-B / L-1000

Safety instructions:

P210: Keep away from heat/sparks/open flames/hot surfaces. - No smoking. **P243:** Take precautionary measures against static discharge. **P261:** Avoid breathing mist/vapours/spray. **P280:** Wear protective gloves/protective clothing/eye protection/face protection. **P273:** Avoid release to the environment. **P301+P310:** IF SWALLOWED: Immediately call a POISON CENTER or doctor/physician. **P303+P361+P353:** IF ON SKIN (or hair): Remove/Take off immediately all contaminated clothing. Rinse skin with water/shower. **P305+P351+P338:** IF IN EYES: Rinse cautiously with water for several minutes. Remove contact lenses, if present and easy to do. Continue rinsing. **P304+P340:** IF INHALED: Remove victim to fresh air and keep at rest in a position comfortable for breathing. **P331:** Do NOT induce vomiting.

Danger instructions:

H225: Highly flammable liquid and vapour. **H315:** Causes skin irritation. **H336:** May cause drowsiness or dizziness. **H304:** May be fatal if swallowed and enters airways. **H411:** Toxic to aquatic life with long lasting effects.



Danger



Vulcanisation solution STG-FW

Safety instructions:

P101: If medical advice is needed, have product container or label at hand. **P102:** Keep out of reach of children. **P261:** Avoid breathing dust/fume/gas/mist/vapours/spray. **P280:** Wear protective gloves/protective clothing/eye protection/face protection. **P273:** Avoid release to the environment. **P302+P352:** IF ON SKIN: Wash with plenty of soap and water. **P305+P351+P338:** IF IN EYES: Rinse cautiously with water for several minutes. Remove contact lenses, if present and easy to do. Continue rinsing. **P308+P313:** IF exposed or concerned: Get medical advice/attention. **P391:** Collect spillage. **P405:** Store locked up.

Danger instructions:

H302+H312+H332: Harmful if swallowed, in contact with skin, if inhaled. **H 315:** Skin irritation possible. **H317:** May cause an allergic skin reaction. **H 319:** Provoke strong irritation of eyes. **H336:** Can bring sleepiness and numbness. **H341:** Suspected of causing genetic defects. **H350:** May cause cancer. **H373:** May cause damage to organs (or state all organs affected, if known) through prolonged or repeated exposure. **H412:** Harmful to aquatic life with long lasting effects.



Danger



Working instructions for splicing fabric belts - hot process



Poison Control Center Berlin
Phone: +49 30 19240

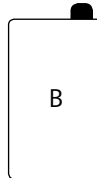

Danger

Cleaning agent type B

Safety instructions:

P210: Keep away from heat/sparks/open flames/hot surfaces. - No smoking. P243: Take precautionary measures against static discharge. P261: Avoid breathing mist/vapours/spray. P280: Wear protective gloves/protective clothing/eye protection/face protection. P273: Avoid release to the environment. P301+P310: IF SWALLOWED: Immediately call a POISON CENTER or doctor/physician. P303+P361+P353: IF ON SKIN (or hair): Remove/Take off immediately all contaminated clothing. Rinse skin with water/shower. P305+P351+P338: IF IN EYES: Rinse cautiously with water for several minutes. Remove contact lenses, if present and easy to do. Continue rinsing. P304+P340: IF INHALED: Remove victim to fresh air and keep at rest in a position comfortable for breathing. P331: Do NOT induce vomiting.

Danger instructions:

H225: Highly flammable liquid and vapour. H315: Causes skin irritation. H336: May cause drowsiness or dizziness. H304: May be fatal if swallowed and enters airways. H411: Toxic to aquatic life with long lasting effects.

Working instructions for splicing fabric belts - hot process

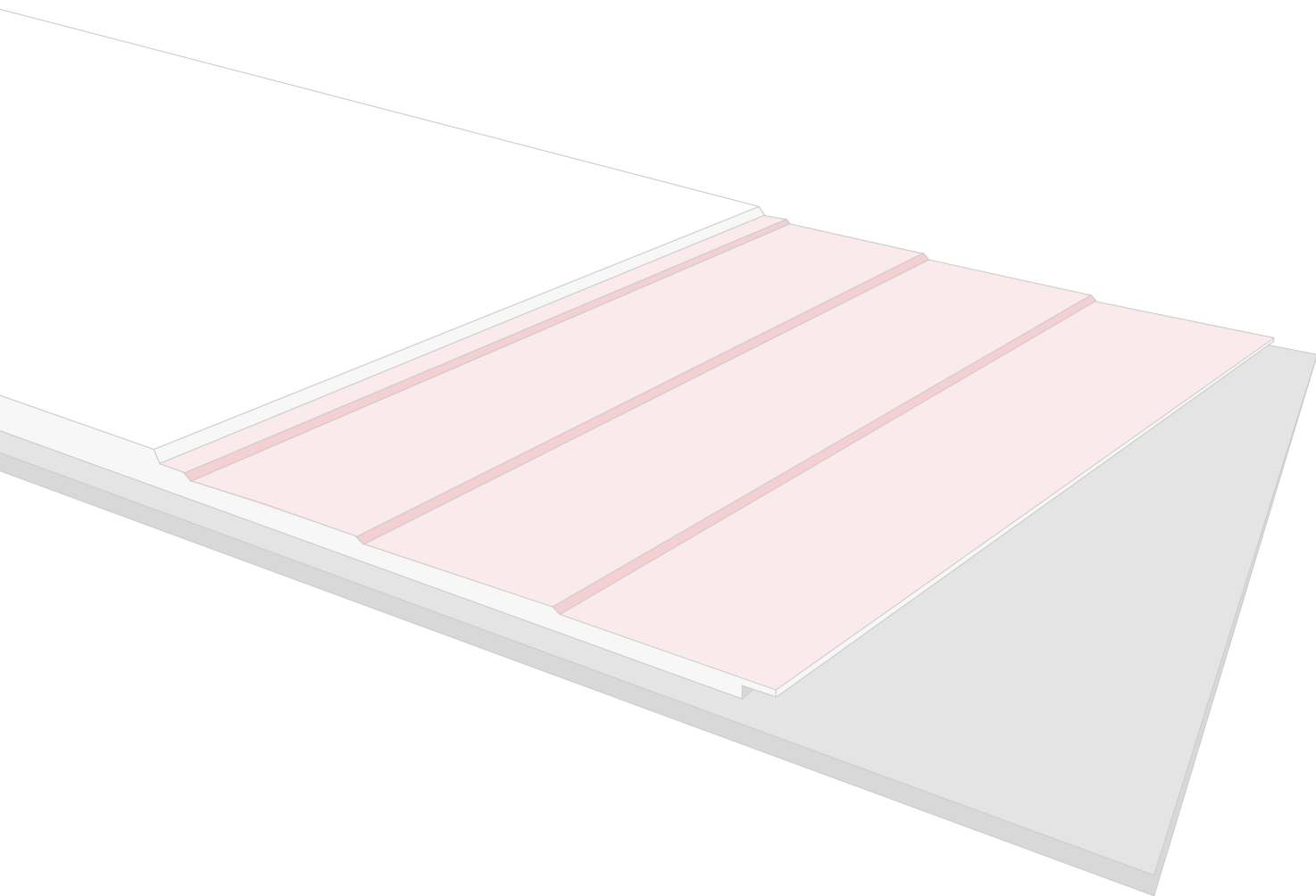



1. Preparations

1.1 Belt transport

For transportation, conveyor belts are usually wound onto wooden cores or, for greater loads, steel cores. (Steel cores are only used in the case of excessive stress and multiple-use, however.) To protect the belt edges and cover plates from excessive sun exposure, you can wrap up the entire belt coil in a film that will also simultaneously protect the belt from transport damage. The belts are often dispatched on drums with no flanged pulleys. This applies specifically to dispatches overseas, as special protection and added security are often desired for the belt edges of transport coils. The belt is then secured against slipping out of place too.

1.2 Loading and unloading

Avoid damaging the belt edges and cover plates when loading and unloading using forklifts, cranes, fixings, etc. Remember before unloading that the belt must be rolled counter to the winding directions. This saves you from having to reposition the belt. If the belt is especially heavy, set distancing beams between the cords and place old belt material or something similar underneath the coil if the surface is sharp-edged.

1.3 Storage

To prevent premature ageing, the formation of cracks, hardening and swelling, protect the belt from the following during storage:

1. Heat and sun exposure
2. Mechanical damage
3. Contact with chemicals, grease and oils
4. Moisture (especially if storing outdoors)

When storing, please observe DIN 7716 for rubber products, guidelines for storage, maintenance and cleaning.

1.4 Planning the vulcanisation

Call a preliminary assembly meeting:

1. What personnel do I require?
2. How will the areas of responsibility be divided up?
3. What is the timeline for the assembly process?
4. What auxiliary equipment is required?
5. Where will the belt reel be jacked up?
6. Where will the belt be fed in? (Exact position)
7. Where will the vulcanisation area be set up?
8. Is full occupational safety guaranteed?

1.5 Jacking up the belt coil

Fit the belt reels and winding shafts to the belt weights and coil diameters. Use cable drum winches with appropriate load-bearing capacity when jacking up. If your belt is heavier, and if it is delivered in a spiral angle, please contact the belt manufacturer regarding the details for jacking up.

1.6 Feeding in the belt

Prepare the start of the belt according to the size. Lift a narrow / short belt using a cable hand winch and in the case of heavy belts, fasten a draw bar at the start of the belt so that it can be connected to a pulling cable. Heavy belts require a motor-driven cable winch or cables in conjunction with a tractor unit such as a lorry or tracked vehicle. Tie up the corners at the start of the belt in the form of a trough before the feed-in or cut them back diagonally.

Safety instructions for descending or ascending areas of the facilities: Install a retaining device. If the brakes should fail or the cord should rupture during the feed-in process, significant damage and safety risks could occur.

Working instructions for splicing fabric belts - hot process

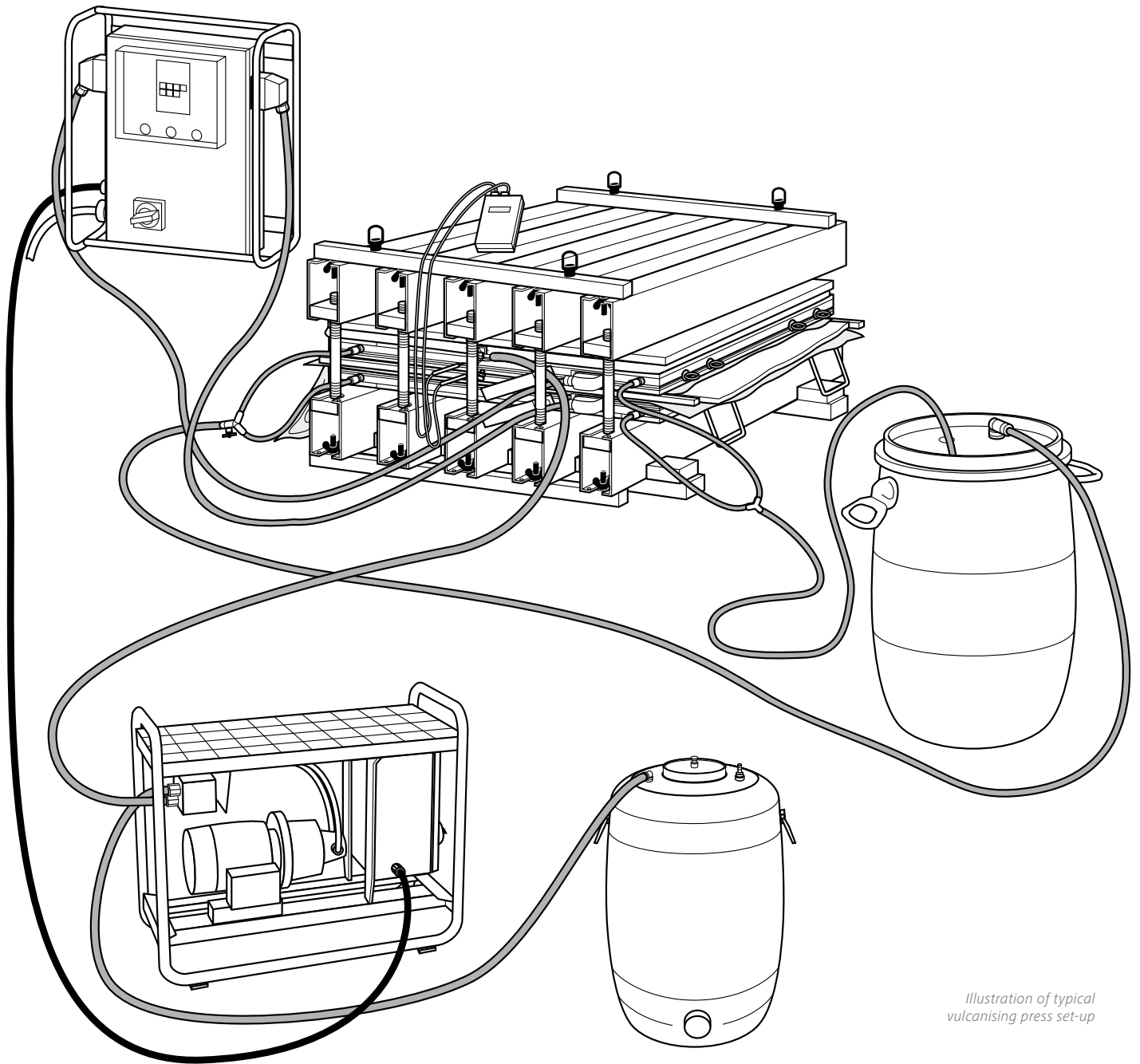

Illustration of typical vulcanising press set-up

2. Set-up of the vulcanising press

2.1 The vulcanisation area

When deciding on your vulcanisation area, ensure that there is enough space, taking into consideration the size of the belt, even ground and, where applicable, adequate protection against weather conditions should the available space permit this.

2.2 Work and working surface

The materials needed to erect a workbench include squared timber and planks. Set up your workbenches in front of and behind the lower part of the vulcanising press; this is the only way the belt heads can be properly worked on and aligned. The workbenches must be the same height as the substructure of your vulcanising press.

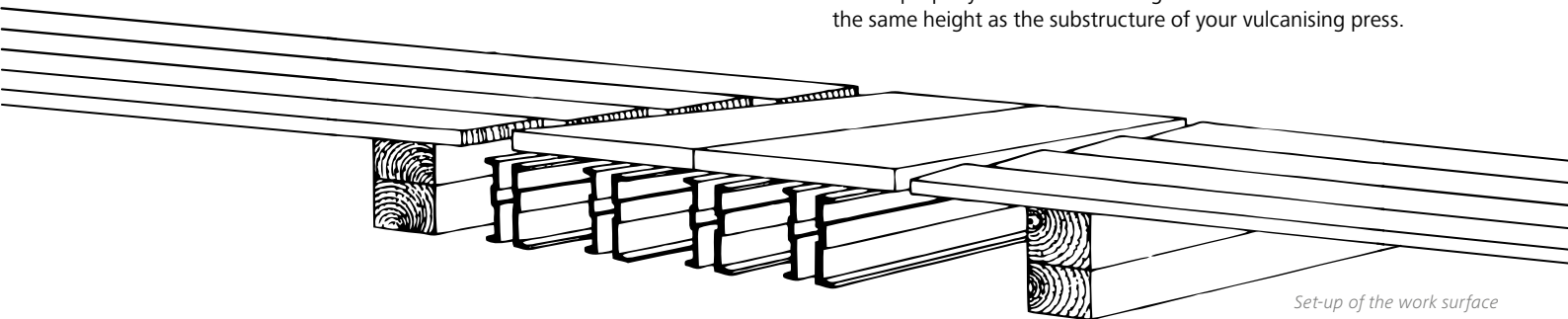

Set-up of the work surface

2.3 Heat and heating plates

The temperature of the heating plates must be constant. Check the heat level of the heating plates using the corresponding end devices, which have been connected for this purpose. Multiple heating plates can be placed alongside one another longitudinally and transversely in order to increase the size of the vulcanising surface. Ensure that the heating plates extend at least 200 mm beyond the length of the splice in the longitudinal direction. In the transverse direction, they may extend only a minimum of 75 mm beyond the width of the belt.

Ensure that, when heating a splice and when a temperature of 145° C +/- 5° C has been reached, a heating time of 3 min. per mm of total thickness is maintained.

E.g.: 13 mm x 3 mm = 39 min. of heating time

Do not open the press until it has reached a temperature of 60° C!

2.4 Pressure and pressure distribution

To achieve proper galvanisation, ensure that uniform pressure is exerted on the vulcanisation area, and that the ground remains even. The pressure distribution during vulcanisation is applied hydraulically or hydromechanically by beams with clamping bolts. Ensure an even pressure distribution over the entire area of the splice.

Steel cord belts: 12 – 15 bar
Fabric belts: min. 7 bar

3. Preparing the ends of the belt

3.1 Splicing guidelines

When preparing for vulcanisation, pay attention to the corresponding splicing guidelines that apply to the type of belt you are working with. These guidelines can be found in DIN 22102 - 3.

For a better overview, please refer to the following table:

3.2 Splice lengths in accordance with DIN 22103 - 3

| Type of belt as per DIN | No. of steps | Minimum step length ¹ l_{st} | Splice length ¹ l_l | Breaking force of a ply N/mm |
|-------------------------|--------------|--|-------------------------------------|------------------------------|
| 315/3 | 2 | 150 | 300 | 80 - 100 |
| 400/3 | | 200 | 400 | 125 - 160 |
| 500/3 | | 200 | 400 | 125 - 160 |
| 630/4 | 3 | 200 | 600 | 125 - 160 |
| 800/4 | | 250 | 750 | 200 - 250 |
| 1000/5 | | 250 | 1,000 | 200 - 250 |
| 1250/5 | 4 | 250 | 1,000 | 200 - 250 |
| 1,600/5 | | 300 | 1,200 | 315 - 400 |
| 2,000/5 | | 300 | 1,200 | 315 - 400 |
| 2,500/5 | | 350 | 1,400 | 500 - 630 |
| 3,150/5 | | 350 | 1,400 | 500 - 630 |

3.3 Belt splice for conveyor belts (with two or more plies and bonding layers)

l_b = bevel
 l_l = splice length
 l_{st} = min. step length
 B = belt width

If $b = 16^\circ 42'$ → $l_b \approx 0.3 \cdot B$

If $b = 22^\circ$ → $l_b \approx 0.42 \cdot B$

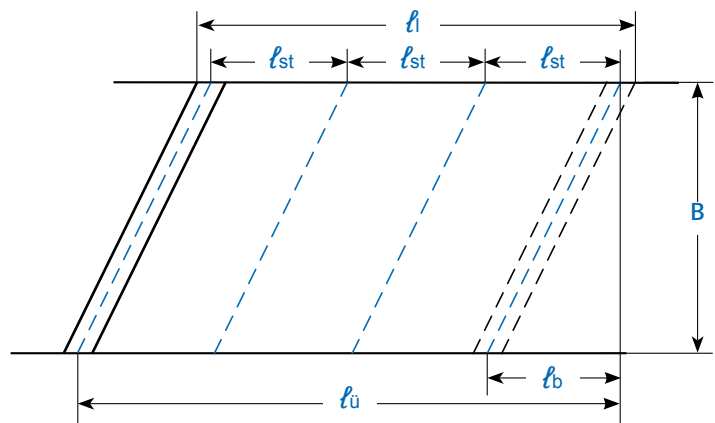

3.4 Running direction

Please observe the running direction of the conveyor belt.

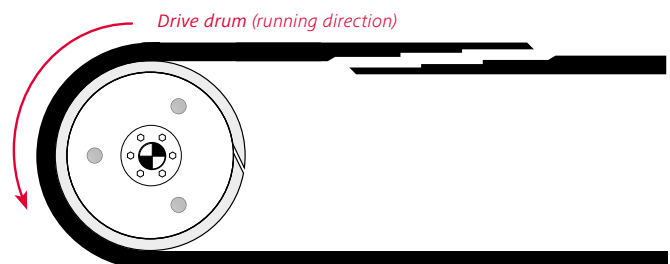

Working instructions for splicing fabric belts - hot process

3.5 Plotting the belt splice

01. First lift the ends of the belt to the prepared work surfaces. Align them and fix them.
02. Next, draw a horizontal crossline at one end of the belt.
03. Push the two ends of the belt together to inspect them. This will allow you to determine whether the centrelines drawn on both ends of the belt are identical and whether they form one long line without interruption.
04. Now draw the individual splice sections and a right-angled crossline (see Figure). The crossline serves as a reference line for plotting the bevelled splice.

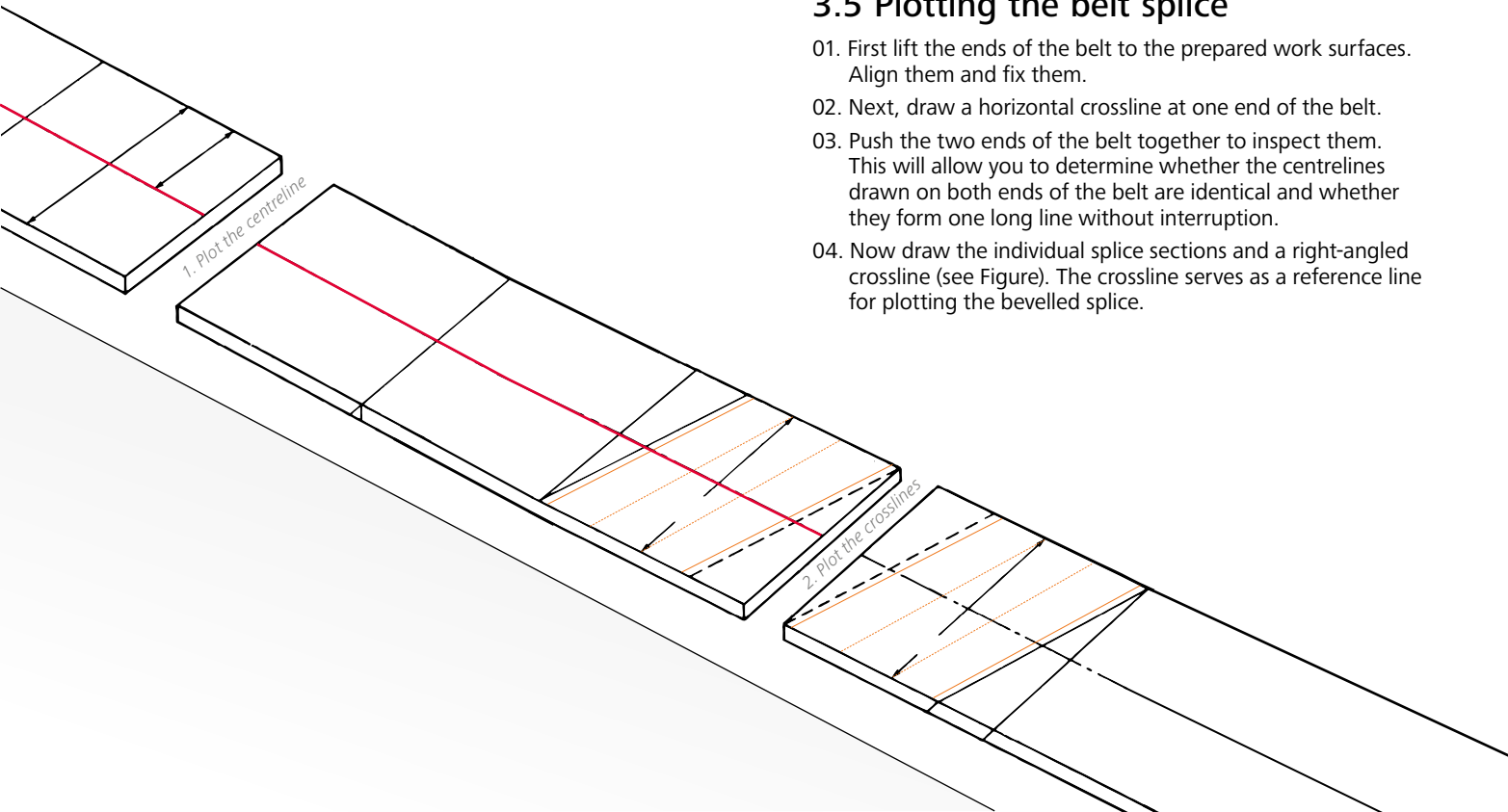

3.6 Conveyor belts with three plies: Two-step splice

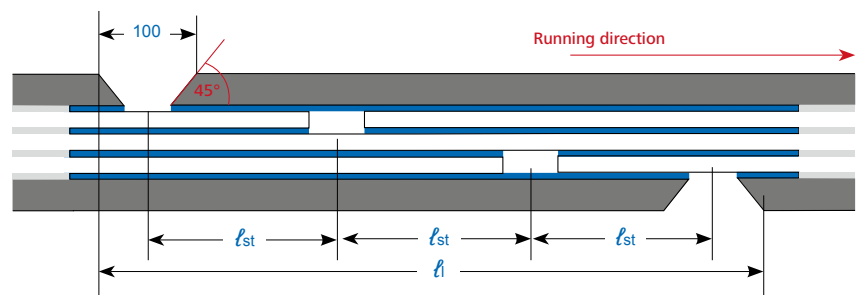

3.7 Activating the adhesive

Stir the adhesive well for 2 minutes to activate it. Observe the processing times and the safety instructions for the respective adhesive.

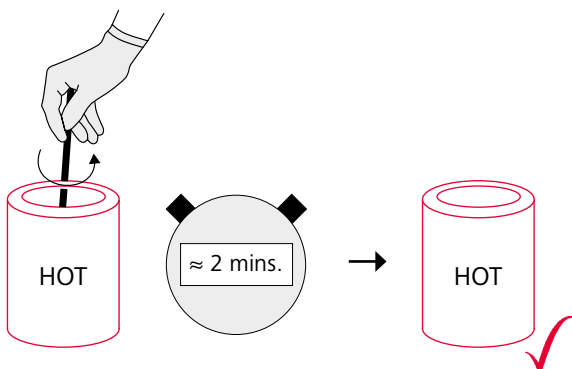

4. Processing the ends of the belt

4.1 Work steps for producing the splice

The following work steps must be performed mirror-inverted for each end of the belt.

01. Score the rubber edge using a cobbler's knife and remove the seam strips using pliers.

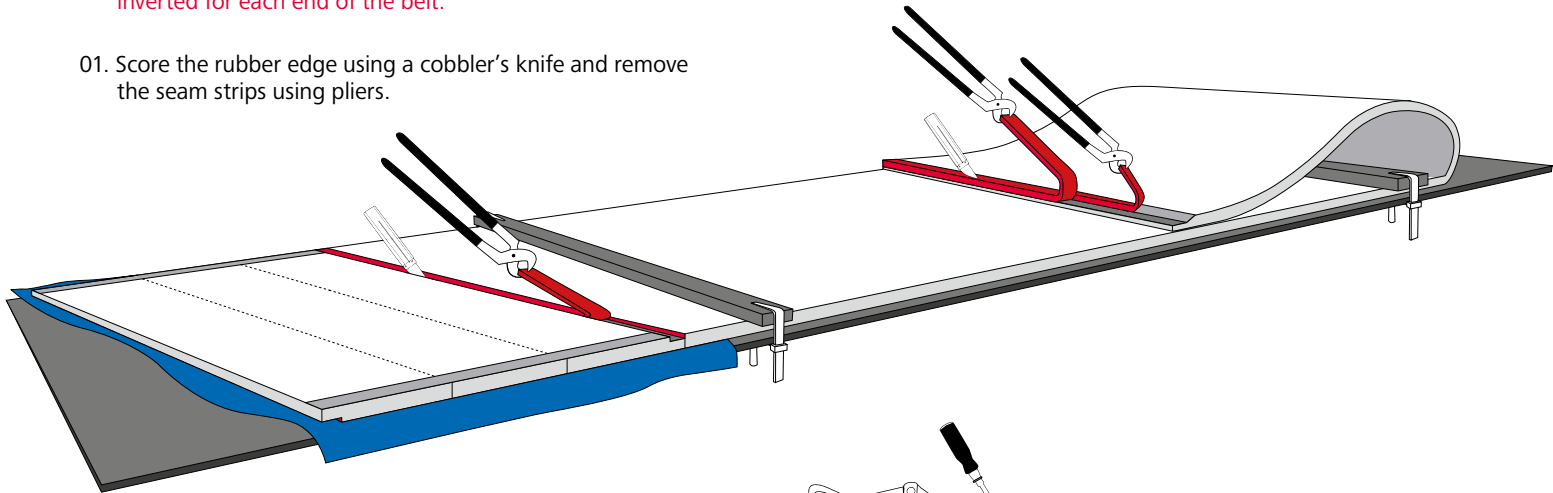

02. Next, score the layer using a layer-separating knife and peel up the steps using a wire grip or a pulling hook.

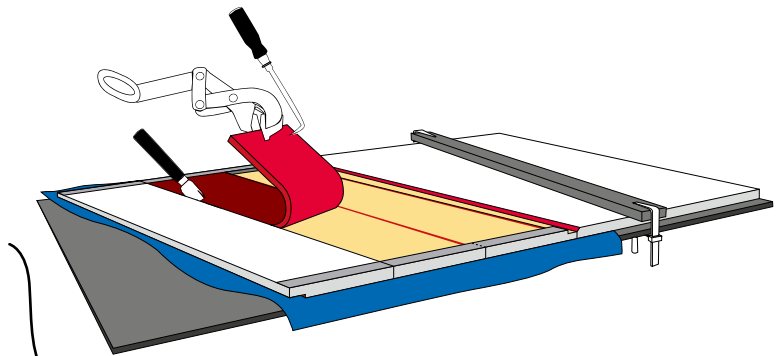

Always take care to ensure that the fabric is not harmed or damaged!

03. Cut the rubber edges off of the step height accordingly using an angled blade. Carefully remove loose rubber material using a rotary sander and then clean it up using a hand brush. Thoroughly brush off the dust. Carefully roughen the rubber edge, the spliced bevel and approx. 30-50 cm above the splice with a wheel wire brush.

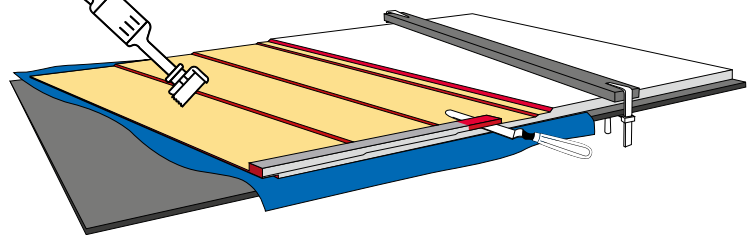

04. Coat both ends of the belt thinly and evenly with the activated hot vulcanisation solution, depending on the respective quality of the rubber, and allow the coating to dry completely. If necessary, coat a second time.

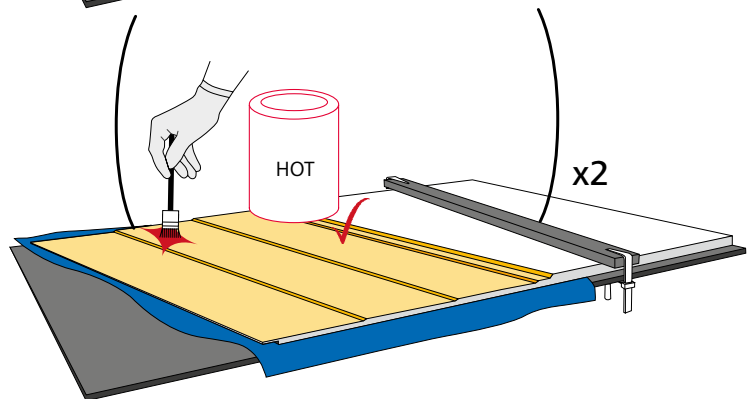

Working instructions for splicing fabric belts - hot process

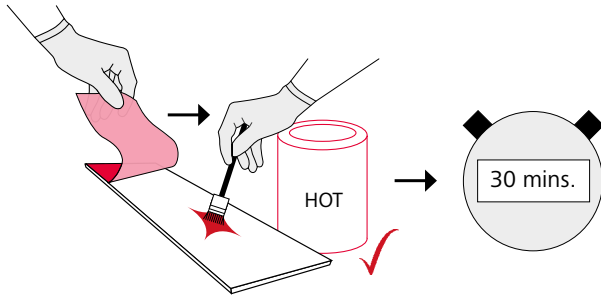

05. Prepare the intermediate rubber, remove the film if necessary, and apply 1x coating evenly on one side.

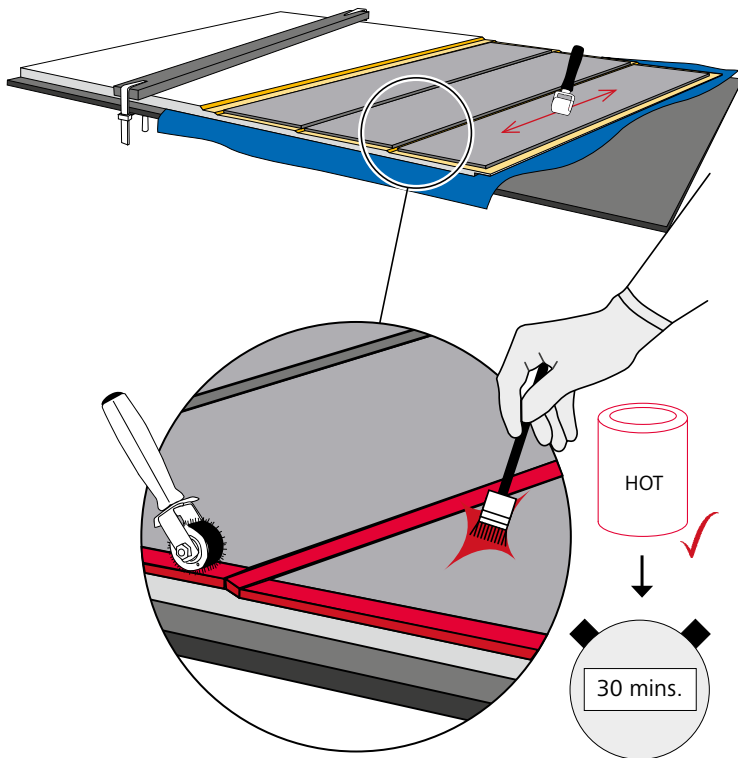

06. Completely cover one end of the belt with the coated intermediate rubber and roll everything evenly from the centre towards the outside edges using a flat roller.

07. Cover the steps and edges of the splice with strips of intermediate rubber that is 2 mm thick and 10 mm wide. Subsequently roll over the strips of intermediate rubber using a piercing roller. Pierce trapped air bubbles and carefully roll these out.

08. Coat the second side of the applied intermediate rubber with vulcanisation solution.

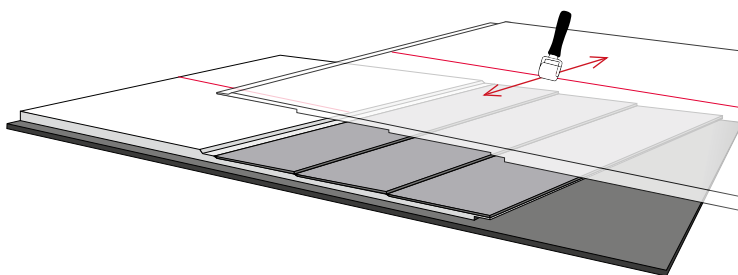

09. Align and bring together both ends of the conveyor belt taking into account the reference line (centreline) and use the hand roller to roll from the centre towards the outside edges in order to expel air cushions.

10. Finally, line the seam strips with a rubber cover plate of appropriate thickness. Recommendation: 1 mm thicker than the thickness of the belt!

Working instructions for splicing fabric belts - hot process

Silicon paper must be placed between the heating plates and the splice. Place edge bars beside the splice and pull towards the edge of the belt using edge tensioners.

Be sure to use edge bars that are 1-2 mm thinner than the conveyor belt!

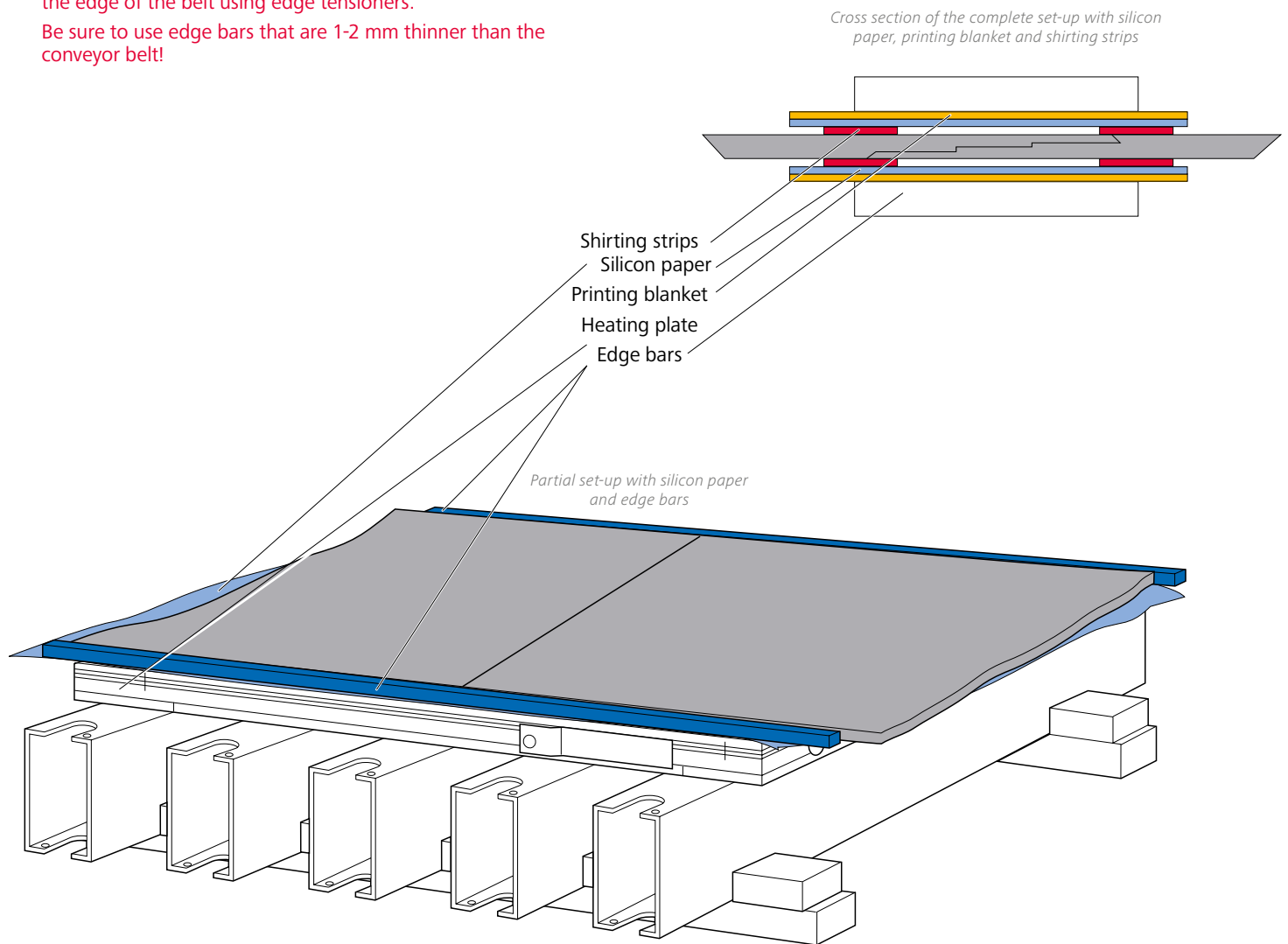

4.2 Cooling down the splices

The following working sequence must be strictly adhered to:

01. First apply the specified pressing pressure and monitor this constantly. Readjust this in the event of pressure loss.
02. To prepare the material and the machine, carry out cold pre-pressing for 15 mins. under constant pressing pressure and then remove all the press pressure.
03. Now you can go back and tighten the tensioning bolts of each of the beams evenly.
04. Switch the press on again. The correct pressing pressure must be reached.
05. Monitor this pressure and readjust as needed.
06. Switch the heating plates on and allow them to heat up until they reach 100° C evenly over the entire pressing surface.
07. Continuously monitor the temperatures of the heating plates and document these temperatures in the splice report.
08. The permitted pressure for the press must not be exceeded (see press operating instructions).
09. Once all heating plates have reached a temperature of 100° C, this will be held for 15 minutes.
10. Then allow the heating plates to heat up to 145° C.
11. Monitor the temperature and the press pressure. Please note in the splicing report any deviations of 10° C or more. The vulcanising period begins once a temperature of 145° C has been reached on all heating plates. This equates to 3 mins. per mm of belt thickness, but no less than 30 mins.
12. Switch off the heating plates once the vulcanising period has lapsed.
13. The splice will stay under pressure until the heating plates have cooled down to 60° C.
14. Now you can release the beams and loosen the edge bars.
15. The press can now be dismantled.
16. Remove the shirting strips, the silicon paper and the printing blanket and check the quality of the splice to ensure the absence of bubbles and pores, elasticity, thickness and shore hardness.
17. Cut the rubber burr from the edges and sand down any uneven points.
18. Permanently mark the splice number as per DIN 22129/22131. The spliced belt can be put into operation once it has been cooled to the ambient temperature.

4.3 Splice report

Complete the splice report fully and sign it. The customer must countersign the report. You will find the report on the following pages (page 18–19).

Protokoll Nr. / Report No.

Erstellungsdatum / Date

Allgemeine Informationen / General informations

Kunde / Customer

Herstellungsbeginn / Start of cure

Gerät/Gurttörderer / Belt

Herstellungsende / End of cure

Servicefirma / service company

Auftragsnummer / Order Number

Details der Gurtverbindung / Details about the belt splice

Fördergurt / Conveyor Belt

Gurtnummer / Number of Belt

Hersteller / Producer Company

Anzahl Gewebeeinlagen / Number of plies

Auftragsnummer / Order Number

Deckplattenstärke / Thickness of Top/Bottom-Cover

Materialnummer / Material Number

Gurttyp / Type of Belt

Gurtverbindung / Splice of Belt

Festigkeit EP / Tension of plies

Verbindungstyp / Type of splice

Vulkanisierpresse / Vulcanizing Equipment

Hersteller/ Typ / Producer/ Company

Verbindungslänge / Length of splice _____ mm

Eigentümer / Owner

MPa

Stufenlänge / Step length _____ mm

Hydraulik/ Wasserdruck / Hydraulic/ Air-Bag

Stück / Piece

Äußere Bedingungen / Environmental

Traversenpaare / Number of Cross-beams (pair)

Zelt / Tent

Wetter / Weather

Heizfolge / Heating

Außentemperatur °C / Outside Temperature F

Heizbeginn / Start up time

Uhrzeit / Time

Temperatur °C / Temperature F

Vulk.-beginn / Start of cure

Uhrzeit / Time

Temperatur °C / Temperature F

Vulk.-ende / End of cure

Uhrzeit / Time

Temperatur °C / Temperature F

Qualitätskontrolle/ Unregelmäßigkeiten / Quality Control/ Irregularities

Servicefirma / Service Company

Schicht oder Tätigkeit / Shift or activity

Datum / Date

Unterschrift / Signature

Schicht oder Tätigkeit / Shift or activity

Datum / Date

Unterschrift / Signature

Schicht oder Tätigkeit / Shift or activity

Datum / Date

Unterschrift / Signature

Arbeitsvorbereitung / Work preparation

Datum / Date

Unterschrift / Signature

Protokoll über die Herstellung der Fördergurtverbindung *Report of making of a splice*

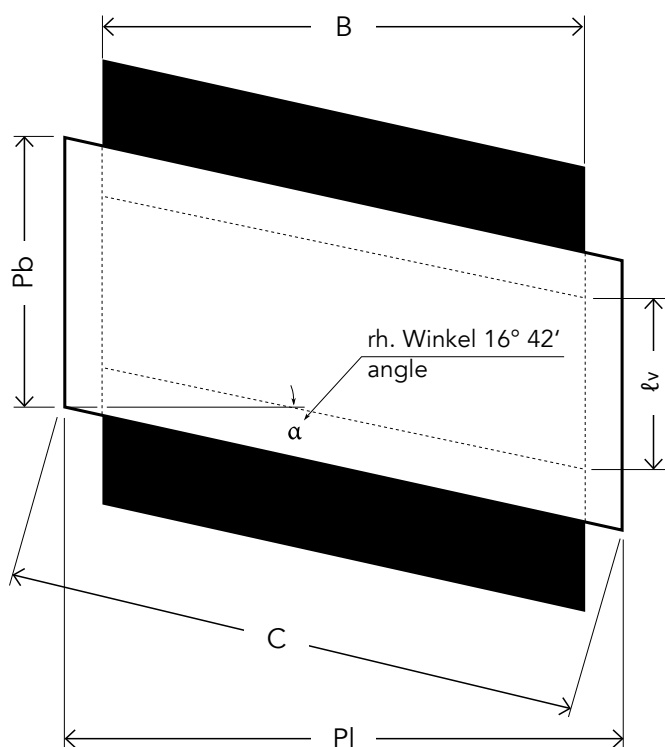

Größenbestimmung der Heizplatte *Dimensions of the heating plate*

| | | |
|--|-------|----|
| Pb = Plattenbreite / <i>plate width</i> | _____ | mm |
| Pl = Plattenlänge / <i>plate length</i> | _____ | mm |
| C = Kantenlänge / <i>edge length</i> | _____ | mm |
| B = Bandbreite / <i>belt width</i> | _____ | mm |
| lv = Verbindungslänge / <i>splice length</i> | _____ | mm |



NILOS

The technical information is based on latest state of technology. We reserve the right to make structural and design changes in the interest of progress. We ask for your understanding that no liability can be assumed for printing errors or mistakes. Reproduction or reprinting, in whole or in part, is not permitted without our express permission.

NAA-VGG-H_EN
This renders all previous instructions invalid.

NILOS GmbH & Co. KG
Reisholzstr. 15
40721 Hilden • Germany
Phone: +49 2103 951-0
Fax: +49 2103 951-209
info@nilos.de
www.nilos.de